



Car Alarm Series 2 B 4 Buttons

G24 SE
(External Shock Sensor)
Version 3

CAR ALARM GENIUS – Series 2B

4 Buttons - G24 Se

(External Shock Sensor)

- Module controlled using Micro-Processor
- 2 Transmitters - 4 buttons with color Blue LED
- 4 Learning Transmitters (Codes)
- Transmission frequency 370 MHz (Anti-Scanner)
- Panic by transmitter
- Car Finder by transmitter
- Transmitter Arm and Disarm Mute
- Programmable Mute Armed and Disarmed
- Negative output Channel 2 (Opens electric trunk)
- Negative output Channel 3 optional modules (Programmable)
- Opening the electric trunk without deactivating the alarm using the transmitter (channel 2)
- LED indicator on the board
- Programmed controls identifier (P.C.I.) (Programmable)
- 1 Positive output for Light flash with internal relay in the module
- Central Door Lock on Negative
- Automatic Armed (Programmable)
- Electric locks on with the Automatic Armed (Programmable)
- Ignition Lock and unlock (Programmable)
- Double push button to unlock door
- Automatic Rearm (accidental disarm)
- Automatic Rearm with Lock
- Shock Sensor bypass by transmitter
- Line door pin switches (Positive or Negative)
- Line hood and trunk pin switches (Negative)
- Electronic siren of 120 dba
- Mode Valet (using emergency button or Transmitters)
- Wires identified by colors
- Protection fuses included in the installation harness
- Transmitter Anti-carjack (Programmable)
- Door Anti-carjack (Optional)
- Ignition Anti-carjack (Programmable)
- Presence Anti-carjack (Additional transmitter) (Programmable)
- Warning Light when anti-carjack activates
- Acoustic warning when anti-carjack activates (Programmable)
- Negative output in armed, for engine cut
- Second engine cut (Programmable)
- Negative output timed for windows-up modules (Programmable)
- Defective zone exclusion
- Flashing output for the horn (Programmable)
- Dome Light (Programmable)
- Function programming through software
- Manual disarmed by safety PIN code (Programmable)
- Memory of last status of the system.

Introduction

Thank you for purchasing our security system for your vehicle. Read well the user's manual of the system specifically the functions of the transmitter, the valet switch and the LED indicator on the board.

The Transmitter

Each transmitter has a different code, the alarm system is programmed by the factory with 2 codes (2 transmitters), and you can program a maximum of 4 codes (4 transmitters). The transmitter has 4 buttons, I, II, III, IV.

The system is pre-programmed with a work routine with each button of the transmitter. It works with the following configuration:

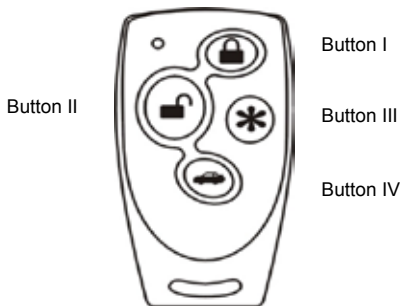

Programming and memory of the transmitters and witnessed transmitters

The alarm system is designed to memorize up to 4 different transmitters, be careful when programming a transmitter, the alarm system deletes from the memory the previous transmitters, program all transmitters at the same time, since through this deletion function you can delete the memory of any transmitter if it is lost by simply programming the transmitter or transmitters again. The witnessed transmitter should be the last one to be memorized.

To enter the memory and be able to program the transmitters, follow these steps:

1. Set the ignition switch in ON
2. Within the first 5 seconds after setting the ignition switch in ON, press and let go the reset button 5 times, the siren will confirm with long sound, you have 10 seconds to enter the transmitters, if you do not enter any transmitter before the 10 seconds or set the ignition switch in OFF, the system will automatically exit the transmitter learning mode and the siren will confirm with 2 sounds and the memory of the transmitters will not be deleted.

Genius Car Alarm

- Press and let go button 1 on the transmitter to program, the siren will confirm with 1 sound the memorization of the transmitter, as of that moment the old transmitters will be deleted.
- If you wish to program a second transmitter, repeat step 3 where the siren confirms with 2 sounds the memorization of the second transmitter and with 3 sounds the third and with 4 the programming ends.

The system pre-programmed with a routine of work with each button of the Transmitter. It works with the following configuration:

Press button 1 once	a. Alarm is armed and the doors are locked	a. IGNITION IS OFF
	b. Stop temporarily the alarm's trigger	b. SIREN SOUNDING
Press button 1 , then button 3 within 2 seconds	Arm the alarm cancelling the shock sensor.	IGNITION IS OFF
Press button 1 , then button 2 within 2 seconds	Arm the alarm cancelling the shock sensor and the doors' signal input	IGNITION IS OFF
Press button 2 once	Disarm and unlock doors	ARMED
	Stop temporarily the alarm's trigger.	SIREN SOUNDING
Press button 4 for 3 seconds	Channel 2 (Open Trunk)	IGNITION IS OFF
Press button 1 for 1 second	Car Finder.	ARMED
Press button 3 for 3 seconds	Panic	IGNITION IS OFF
Press buttons 1 and 2 together for 3 seconds	Anti-hijacking	IGNITION IS ON
Press button 3 , then button 1 within 2 seconds.	Silent Arming Mode	IGNITION IS OFF
Press button 3 , then button 2 within 2 seconds.	Silent Disarming Mode	ARMED
Press button 4 , then button 3 for 3 seconds.	Valet Mode	IGNITION IS OFF
Press buttons 3 and 4 together for 2 seconds.	Arm Channel 3	IGNITION IS ON/OFF

Alarm system armed.

The alarm system can be armed in 2 methods.

1. The first, using button I on the transmitter. It is necessary for the ignition switch to be OFF and for the system not to be on Valet.
2. The second, using the automatic armed, which is obtained when the ignition switch goes from ON to OFF and then open and close a door. The system will automatically arm in 30 seconds after closing the last door, this functions is programmable (see function programming chart).

Alarm system armed by using the Transmitter.

The alarm system will always be armed by using the transmitter, provided that the ignition switch is OFF and the system in not in the Valet mode.

To arm the alarm system after leaving the vehicle and closing all the doors, simply press and let go button I on the transmitter once, the lights will flash once, the siren will sound once and the LED indicator on the board will start flashing slowly to confirm that the system in armed. If the electric locks are connected to the alarm system, they will be locked; the current breaker will be activated avoiding the use of the vehicle, after 3 seconds the system goes to expecting-robbery mode

Exclusion of defective zones.

When the alarm system is armed and if any of the zones is defective, the siren shall sound 3 times and, simultaneously, the lights will flash 3 times, indicating that a zone is defective, when this occurs, the defective zone will be automatically excluded and the vehicle will be protected on the rest of the zones. For example, if the trunk is not closed properly after arming the alarm system using the transmitter, the siren will sound 3 times and the lights will flash 3 times indicating a door is not properly closed and it will exclude the sensors of that zone. The defective zone will be included again in the protection 3 seconds after correcting the failure, after properly closing the trunk.

Armed and activated alarm system.

When the alarm system is armed, the LED indicator on the board blinks slowly, if a door is opened, the siren starts sounding and the lights flashing for 60 seconds, if the door remains open after the 60 seconds, the siren will keep sounding and the lights flashing for 3 minutes, after the 3 minutes, the alarm system excludes the door sensors protecting the vehicle through the rest of the sensors, if the door is closed before the first 60 seconds after the siren start sounding, the same will silent after 60 seconds and the light will stop flashing.

If when the alarm system disarms the siren sounds 4 times and the lights flashes 4 times, this indicates the vehicle was victim of a carjack attempt. The LED indicator on the board will continue to blink until the ignition switch is ON. Please check the vehicle.

Alarm System Disarm

When the alarm system is armed, press and let go button No. II on the transmitter, the siren will sound twice and the lights will flash twice indicating the alarm system disarmed, the current breaker will deactivate, the LED indicator on the board will turn off, if the electric locks are connected, they will open, if button II is pressed again, the system will send the second pulse to open the electric locks

Silent Arm

First press and let go button III and then press and let go button I on the transmitter to arm the alarm system silently, the alarm system will arm without the sound of the siren. When the alarm is silently armed and a door is open or not properly closed, the siren will sound 3 times as an alert warning.

Silent Disarm

First press and let go button III and then press and let go button II on the transmitter to disarm the alarm system silently, the system will disarm without the sound of the siren. When silently disarmed and after the vehicle has been victim of a carjack attempt, the siren will sound 3 times as an alert warning.

ARMING WITH ZONES' CANCELLATION

This system allows us to arm the alarm cancelling the shock sensor as the 1st zone and the shock sensor and doors' signal as the 2nd zone. This is to avoid false alarm when the shock sensor or the doors' switch is triggered.

1. Press **button 1**, then press **button 3** within two seconds, the shock sensor is cancelled.
2. Press **button 1**, then press **button 2** within 2 seconds, both the shock sensor and the door's signal are cancelled.

DOORS' SIGNAL ARMING DELAY

This function allows us to arm the alarm even when the dome lights are on, because the system will not recognize this signal for the programmed time, avoiding notices of open door when the alarm is armed.

* See Programming Table-

Disarm of the system using the reset button

In case you lose the transmitter, damage it or the battery of the same dies, you can disarm the system by pressing the reset button.

First, with the security system armed, open the driver's door and the siren will start sounding.

Second, turn ON the ignition switch, before the 10 seconds press the reset button the number of times assigned in the security code (1 as set by the factory) the siren will continue to sound for 3 seconds and if the security code is right the system will disarm.

PANIC

With this function, we can make the system to trigger intentionally to prevent or attract the attention of people, in case of a theft or aggression attempt.

- a. With the ignition in OFF,
 - PANIC, **BUTTON 3 FOR 3 SECONDS**
- b. The siren and the lights will trigger for 3 seconds.
- c. Press **button 1** or **button 2** to stop PANIC, the system will remain armed.
- d. With the ignition in **ON**. Activate PANIC.

By stopping PANIC, the system will remain armed without the ignition interrupter, but if the ignition key is turned to OFF position, the IGNITION INTERRUPTER will be activated.

CAR FINDER

With this function we can make the system to send us signals with the siren and lights, which will serve us to locate the vehicle, whenever we are in the transmission range between the remote control and the vehicle.

- a. When the alarm is armed,
 - CAR FINDER, **BUTTON 1 FOR 1 SECOND**
- b. The siren will chirp 10 times and the parking lights will flash 10 times.
- c. Press **button 1** or **button 2** to stop the Car Finder.

DUAL-STAGE SHOCK SENSOR

If the vehicle receives a **light impact**, the siren will chirp and the lights will flash 5 times each. If the vehicle receives a strong impact, the siren and the lights will trigger for 30 seconds.

*The sensitivity can be adjusted.

ANTI-HIJACKING BY IGNITION (Programmable by Jumper)

This function is in the memory's software to activate automatically the anti-hijacking mode every time the ignition key is turned from OFF position to ON position. (See Jumpers table)

ANTI-HIJACKING BY TRANSMITTER (Programmable)

This function is used to immobilize the vehicle in case of emergency, pressing the buttons 1 and 2 simultaneously for 3 seconds and the anti-hijacking mode will be activated by transmitter. (See Functions Programming Table)

ANTI-HIJACKING BY DOORS (Programmable)

With the ignition key in ON position, open driver's door and the anti-hijacking mode by door will be activated. You must connect the wire of anti-hijacking by door. (See Functions Programming Table)

WITNESSED ANTI-CARJACK (Additional transmitter necessary)

This function is used to immobilize the vehicle in case of emergency by simply separating the additional transmitter while the engine of the vehicle is working, 60 seconds after the signal disappears, the lights will flash twice, The LED indicator will start blinking indicating the anti-carjack has been activated, if the acoustic warning is programmed, the siren will sound twice.

This function is programmable (see function programming chart).

For the witnessed anti-carjack to function, the additional transmitter must be acquired. It must be programmed in the alarm system memory and enable function in the function chart.



Optional witnessed transmitter

Turning on the transmitter

Press the button on the transmitter and hold it, the LED indicator on the transmitter will turn on and off, after 3 seconds the LED on the transmitter will turn on for 2 seconds. Let go the button on the transmitter.

The transmitter will send a signal to the receiving module (Central Unit) every 6 seconds.

When the internal battery of the transmitter is dead, the LED transmitter will warn you by continuously blinking. You must replace the batteries of the transmitter.

Turning off the transmitter

Press the button on the transmitter and hold it, the red LED on the transmitter will flash once, after 3 seconds, the LED of the transmitter will flash 5 times. Let go the button of the transmitter.

ANTI-HIJACKING SEQUENCE

When the system enters in anti-hijacking mode,

- a. **0 to 15 seconds**, nothing happens (See Functions Programming Table, function 9).
- 16 to 30 seconds**, the LED twinkles slowly.

31 to 45 seconds, the LED will flash rapidly, the siren will chirp once every two seconds and the lights will flash once every second.

46 to 70 seconds, the LED will flash rapidly, the siren will chirp once every second and the lights will flash once every second.

After 70 seconds, the siren and the lights will trigger, the engine interrupter will be activated.

- b. When the anti-hijacking is triggered, (the ignition remains in ON position). Even if the ignition key is turned to OFF position, the siren and the lights remain triggered for 3 minutes.
- c. If the ignition key is turned to ON position again, the siren and the lights will be triggered again.

*To exit Anti-hijacking mode: **APPLY THE DISARMING EMERGENCY PROCEDURE**

AUTOMATIC ARMING

This function provides us with a greater confidence in our alarm, giving us security and tranquility because of the alarm's complete protection.

With this function we can assure that the system will arm automatically in case we forget to do so.

* For more security, it is recommended to arm the system with the remote control.

- a. After turning the ignition key to ON position and closing the doors, 30 seconds later the alarm will be automatically armed.

* See **Jumper 1** selection for MANUAL / AUTOMATIC Arming

* See Programming Table for Automatic Arming Programming with doors lock.

AUTOMATIC REARMING

When the alarm is disarmed with the remote control, without turning the ignition key to ON position and without opening the doors, 30 seconds later the alarm will be re-armed and the doors will be locked.

CHANNEL 2 (TRUNK)

- a. When the alarm is disarmed:

CHANNEL 2, **BUTTON 4** FOR 3 SECONDS, the signal is triggered (The trunk will be opened)

- b. When the alarm is armed:

Activating channel 2, first the alarm will be disarmed and then the signal is triggered. (The trunk will be opened)

* See Programming Table

CHANNEL 3

With this signal we can control a function (connecting an additional- optional module) such as a window module, or the engine ignition.

Press buttons **3** and **4** together for two seconds to activate the function. (If the buttons are pressed for more time, the signal is applied; releasing the buttons will stop the signal)

* See Programming Table

SECOND PULSE TO UNLOCK DOORS

If we wish to control the doors lock as AGENCY TYPE, with this function we can do it.

Disarming the alarm pressing the **Button 2** once, only the driver's door will be unlocked. If we press **Button 2** again, within three seconds the others will be unlocked.

*See Programming Table

HORN OUTPUT

Normally, in alarms the sound is produced by a siren (Positive Output), with this new system, we can simultaneously drive the horn's sound (Negative Output), or select one of the two functions.

* See programming Table

VALET MODE

Valet, it is the function that allows us to cancel temporarily our security system, for those situations in which we do not want to use the alarm system, for example in the car washer, while in maintenance services, etc.

1. Valet by Remote Control

a. While the alarm is disarmed, press **BUTTON 4** once. Within 3 seconds, press **BUTTON 3** for 2 seconds.

b. The LED will light solid and the siren will chirp 5 times, confirming that the system is in Valet mode.

c. If the system is in Valet mode: If we press **BUTTON 1**, the doors will be locked and the lights will flash once if **BUTTON 2** is pressed, the doors will be unlocked and the lights will flash twice. d. To exit Valet mode, apply the previous mentioned procedure.

*The LED will turn off.

2. Valet by Reset Switch.

a. When the ignition key is in ON position, keep pressing reset switch until the siren chirp 5 times.

b. The LED will light solid confirming that the system is in Valet mode.

c. To exit Valet mode, apply the previous mentioned procedure.

* The LED will turn off.

DOORS LOCK WITH IGNITION

The overall alarm system offers us a comfortable and secure operation, and this function is one of them.

a. After the engine ignition is on, the doors will be locked 2 seconds later.





b. Once the engine is turned off, the doors will be unlocked immediately.

DOOR LOCKS' CONTROL WITH THE TRANSMITTER WHILE DRIVING





While driving, if we press **button 1**, the doors will be locked; and if we press **button 2**, the doors will be unlocked.

FUNCTIONS' SELECTION - JUMPERS

Important: All the Jumper's selections have to be determined before installation.

JUMPER	MODE	DEFAULT FABRIC CONFIGURATION	MODE	VARIANTS
J1: AUTOMATIC ARMING / MANUAL ARMING		AUTOMATIC ARMING		MANUAL ARMING
J2: DOOR LOCKS' TIME		0.5 SECONDS		DOUBLE PULSE

Genius Car Alarm

J3: DOORS' POLARITY (+ O -)		DOORS' INPUT (-)		DOOR'S INPUT (+)
J4: ANTI-HIJACKING BY IGNITION		ACTIVATED (ON)		DEACTIVATED (OFF)

INSTRUCTIONS

* LED'S CONDITIONS

- a. Armed Alarm: The LED will flash slowly (once every second)
- b. Automatic Arming and Re-arming: The LED will flash rapidly.
- c. Valet Mode: LED will light solid.

* TRIGGER DIAGNOSIS – LED

Disarming the alarm after it was triggered will make the LED to flash, indicating us the zone that triggered the alarm.

- Triggered by Ignition -----The LED will flash once.
 Triggered by Opened Door -----The LED will flash 3 times.
 Triggered by Shock Sensor-----The LED will flash 4 times.

FUNCTIONS PROGRAMMING

- a. Turn the ignition key to ON position.
- b. Within 10 seconds, press the valet switch **5** times.
- c. The siren will chirp 3 times.
- d. Press the valet switch the number of times of the selected function.
 - * The siren will sound every time the valet switch is pressed.
- e. Press the **button** in the remote control of the selected option.
 - * If the **button 1** is pressed, the siren will chirp once (1); if the **button 2** is pressed, it will chirp twice (2), and three chirps if **button 3** is pressed.
- f. To exit the programming mode, turn the ignition key to OFF position.
 - * The siren will sound a (1) long beep.

PROGRAMMING TABLE

Times the Valet switch is pressed	FUNCTION	Press button 1	Press button 2	Press button 3
1	Lock closure with automatic arm	YES	NO	
2	Door's Signal Activation Delay	WITHOUT DELAY	Delay of 30 seconds	Delay of 60 seconds
3	Anti-hijacking by transmitter	YES	NO	
4	Lock Doors with Ignition	YES	NO	
5	Unlock Doors with Ignition	YES	NO	

Genius Car Alarm

6	OUTPUTS FOR CHANNEL 3	Second Pulse to Unlock Doors	CHANNEL 3	HORN OUTPUT (-)
7	Anti-hijacking Warning *Indicates the beginning of the sequence	YES	NO	
8	ARMED and DISARMED Notices	YES	NO	
9	Reminder to arm the alarm. *Only in Manual Arming	YES	NO	
10	Opened Door Warning	YES	NO	
11	Channel 2	Electric Trunk	Dome Light	30 second Electric window lifter
12	Anti-hijacking by Door	Close Door	Open Door	
13	FABRIC RESET	SI		
14	Witnessed Anti-carjack (Additional Transmitter)	OFF	ON	
15	Programmed controls identifier (P.C.I.)	ON	OFF	

* Example to do the Programming:

- a. Select the functions to be changed. (It is recommended to write down them to avoid mistakes)
- b. If you are going to work with 2 or 3 functions, follow these steps:
- c. Function # 2: Press valet switch twice and then select **button 1**.
- d. Then, if you wish to program, function #4, press twice again the valet switch (to complete the # 4) then select **button 2** of the remote control.
- e. And then, if you also want to program function # 8, press four times the valet switch (to complete the # 8), select the **button 2** of the remote control.

IMPORTANT: Going from one function to another, just press the valet switch the number of times necessary to complete the following function.

DETAILS OF THE PROGRAMMING FUNCTIONS

1. LOCK CLOSURE WITH AUTOMATIC ARM

If we programmed the Automatic Arming function (JUMPER 1), the alarm will arm by itself, so with this function 1 we can choose to unlock or lock the doors.

2. DOORS' SIGNAL ARMING DELAY

This function allows us to arm the alarm even when the dome lights are on, because the system will not recognize this signal for the programmed time, avoiding notices of open door when the alarm is armed.

3. ANTI-HIJACKING BY TRANSMITTER

This function is used to immobilize the vehicle in case of emergency; pressing the buttons 1 and 2 simultaneously for 3 seconds while the engine is running, the siren will chirp once and the parking lights will flash once; after 15 seconds, the LED will start to twinkle indicating the activation of the anti-hijacking mode. This function is programmable (See Functions Programming Table)

4 and 5 DOORS LOCK WITH IGNITION

This function provides us comfort and security. When the engine is turned on, the doors will **lock** TWO seconds later. When the engine is turned off, the doors will unlock immediately.

6. OUTPUTS FOR CHANNEL 3

Select a function from one of these three options:

1. CHANNEL 3- Output to drive an optional function, such as a windows module.
2. SECOND PULSE TO UNLOCK DOORS
3. HORN OUTPUT- * NEGATIVE OUTPUT *

7. ANTI-HIJACKING WARNING: BEGINNING OF THE SEQUENCE

When this function is activated, triggering the anti-hijacking will make the siren chirp once.

8. ARMING OR DISARMING WARNINGS

When arming the alarm, the siren will chirp once; when disarming the alarm, the siren will chirp three times. Sometimes, the chirps may be annoying, so the system gives us the option to cancel temporarily these warning sounds.

9. REMINDER TO ARM THE ALARM

When we get off the vehicle and close the last door, **5** seconds later the siren will chirp three times and **10** seconds later other three chirps will be produced, indicating that we have **not** **armed** the **alarm**.

* This function will only activate if in **MANUAL ARMING MODE**

* See Programming Table

10. OPENED DOOR WARNING

While driving, if one of the doors is opened, the lights will flash for 60 seconds. In case the door keeps open and is closed before the 60 seconds, the lights will turn off.

11. CHANNEL 2

Function's Selection- Trunk's release or dome lights:

DOME LIGHTS – Negative Output Signal for 20 seconds. When disarming, if the ignition key turns to ON, the dome lights turn off.

TRIGGERED, the dome lights are intermittent.

12. ANTI-HIJACKING BY DOOR (Open / Close)

With the ignition key in ON position, open or close the driver's door, the siren will sound once and the parking lights will flash once indicating the activation of the anti-hijacking mode. For the anti-hijacking by door to work, you must connect the anti-hijacking by door wire to the push-button (-) in the driver's door.

13. FABRIC DEFAULT RESET

This function allows us to correct the errors, if we mistaken during programming.

14. WITNESSED ANTI-CARJACK (ADDITIONAL TRANSMITTER NECESSARY)

This function is used to immobilize the vehicle in case of emergency by simply separating the additional transmitter while the engine of the vehicle is working

15. PROGRAMMED CONTROLS IDENTIFIER (P.C.I.)

Every time you set the key in ON, the LED will light immediately for 10 seconds, to indicate the number of remote controls that were programmed.

1. Intermittency /pause = 1 control programmed
2. Intermittency /pause = 2 controls programmed
3. Intermittency /pause = 3 controls programmed
4. Intermittency /pause = 4 controls programmed

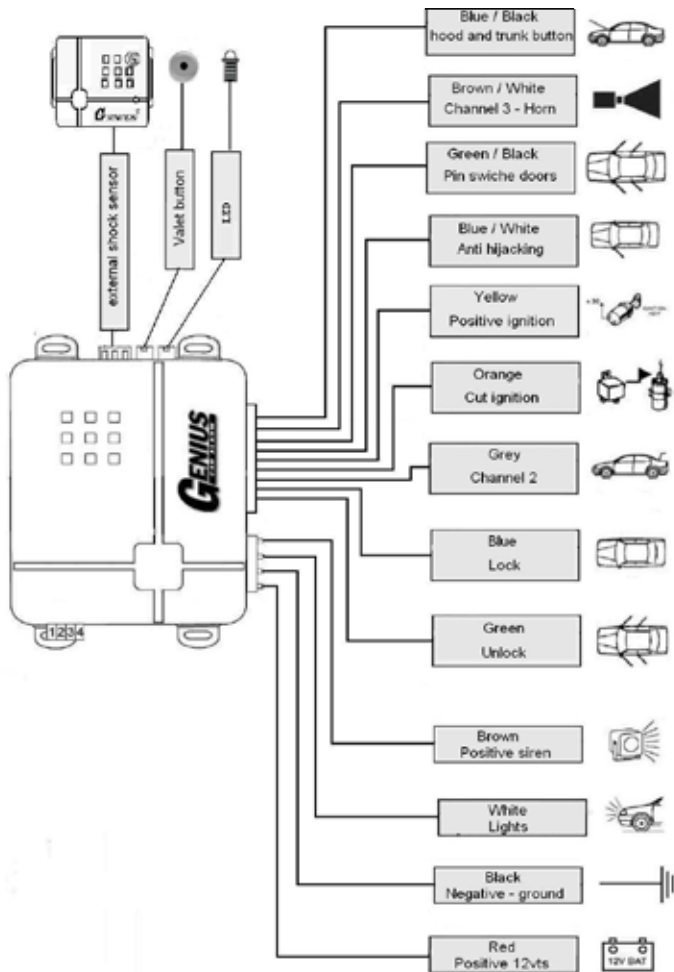

Genius Car Alarm

Purchase Date: _____ Invoice _____

BENEFICIARY

Name: _____

C.I.: _____

Vehicle's Trademark: _____ Color: _____

Model: _____ Vehicle's Plate: _____

STAMP AND SIGNATURE OF THE DISTRIBUTOR THAT INSTALLED THE SYSTEM

TECHNICAL REVISION

1ST Date _____

Observations _____

Stamp: _____

2nd Date _____

Observations _____

Stamp: _____

3rd Date _____

Observations _____

Stamp _____

LIMITED WARRANTY

Every GENIUS branded alarm system is guaranteed for () year(s) since the installation date considering the following conditions:

1. This warranty does not cover damage or malfunctions caused by:
 - a. Immersion in water or liquids
 - b. Shocks or fire
 - c. Attempted modification or repair by unskilled hands
 - d. Controls' Loss or Degradation
2. The costs of dismantling, assembling or any other will be borne by the claimant.
3. The implementation of this guarantee will have greater flexibility in its dealings, if the user has placed the sticker on the rear window of the vehicle.
4. The technical department of the company reserves the right to determine the validity of the guarantee according to expertise.

WARNING: The Anti-hijacking is exclusively a deterrent against possible theft. In no case it can be considered as an insurance against theft. The manufacturer disclaims all liability for damage or abnormal functioning of the alarm, accessories and automotive group, due to improper installation or monitoring of the characteristics listed.

Recommendations for Storage

Take it with you always

1. Anti-hijacking Disarming

With the ignition key in ON position, press the reset button 1 time, wait 3 seconds and the anti-hijacking mode will be disarmed.

2. Manual Disarming

Turn the ignition key to ON position, press the reset button 1 time, wait 3 seconds and the alarm's system will be disarmed.

3. Enter and Exit Valet Mode

With the ignition key in ON position, press and hold reset button for 5 seconds, the LED will light solid; to exit Valet mode, with the ignition key in ON position, press and release reset button, the LED will turn off.

Important: Plastic and store these instructions and take it with you always.

Technical Specification

(1) Frequency	370 MHz
(2) Working Voltage	From 9.5V to 16V
(3) Standby Current for ARM Mode	13mA
(4) Standby Current for DISARM Mode	11mA
(5) Maximum Parking Light Output	15A
(6) Maximum Negative Output for Trunk, Dome Light, 3 rd Channel	Negative 0.5A
(7) Maximum Central Door Lock Output	Negative 0.5A
(8) Combination of Fixed code in Transmitter	1,0480576